

S80

Linear stem actuator
Thrust force 800N
Adjustable stroke max. 1000 mm



PRODUCT DESCRIPTION

Linear electric actuator Topp model S80 with self-aligning tilting movement, complete with support and fitting accessory for top hung windows or sun blades and louvers. Operation at 230V 50Hz, or, as an alternative, at 24V DC. Max. traction and thrust force 800N. Preset for the synchronous operation of two actuators on the same window. Available strokes: 200 - 400 - 600 - 800 - 1000mm. Worm screw in stainless steel and IP68 protection degree for 200 and 400mm strokes. IP65 for 600, 800 and 1000mm strokes. CE marked device.



High degree of protection against dust and water IP68.

Stainless steel drive.

Millimetrically adjustable stroke.



TECHNICAL SPECIFICATIONS

	S80 230V	S80 24V
Power Supply voltage *	230V ~ 50Hz	24V d.c.
Maximum load applicable in thrust	800 N	800 N
Maximum applicable load in traction	800 N	800 N
Strokes	200 - 400 - 600 - 900 - 1000 mm	
Absorbed current	0,2 A	1A
Idle translation speed	6,5 mm/s	6,5 mm/s
Duration of the idle stroke	(stroke/idle translation speed)	
Double insulated	YES	YES
Service type	S2 of 3 min	S2 of 3 min
Operating temperature	-20°C + 60°C	-20°C + 60°C
Protection class	IP 68 (200-400strokes) IP65 (600-800-1000 strokes)	
Parallel connection	YES	YES
Synchronous operation of more actuators on the same window	YES	YES
Stroke end	mechanical / electronic	mechanical / electronic

* power supply cable not included

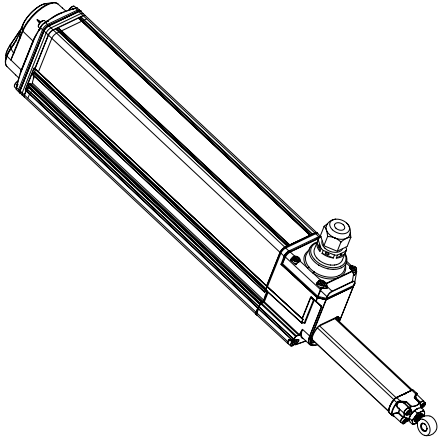

S80 standard 1 push point

3B20#	S80 linear stem actuator 230V stroke 200mm
3B20#	S80 linear stem actuator 230V stroke 200mm (louvers)
3B20#	S80 linear stem actuator 230V stroke 400mm
3B20#	S80 linear stem actuator 230V stroke 400mm (louvers)
3B20#	S80 linear stem actuator 230V stroke 600mm
3B20#	S80 linear stem actuator 230V stroke 800mm
3B20#	S80 linear stem actuator 230V stroke 1000mm

3B20#	S80 linear stem actuator 24V stroke 200mm
3B20#	S80 linear stem actuator 24V stroke 200mm (louvers)
3B20#	S80 linear stem actuator 24V stroke 400mm
3B20#	S80 linear stem actuator 24V stroke 400mm (louvers)
3B20#	S80 linear stem actuator 24V stroke 600mm
3B20#	S80 linear stem actuator 24V stroke 800mm
3B20#	S80 linear stem actuator 24V stroke 1000mm

Description of the standard 1 push point pattern for top-hung windows

3B20#	S80 linear stem actuator 230V stroke 200mm
	Actuator supporting bracket
	Fitting bracket to the frame
	Spare parts

Description of the standard 1 push point pattern for louvers

3B20#	S80 linear stem actuator 230V stroke 200mm
	Actuator supporting bracket for louvers
	Spare parts for louvers

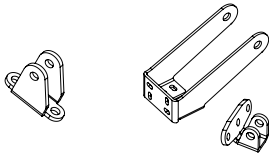

Accessories and spare parts

1B2801	Actuator supporting bracket
1B2800	Actuator supporting bracket for louvers
1S1604	Fitting bracket to the frame
3B2001	Spare parts for top hung windows
3B2002	Spare parts for louvers
1B2120	Feeding cable for synchronization (2m)

